

# 2404 2408

MODELS



## Controller/Programmer Specification Sheet

- **High stability control**
- **Up to twenty programs**
- **16 segments**
- **Heating and cooling**
- **Customisable operation**
- **Heater current display**
- **Multiple alarms on a single output**
- **DC retransmission**
- **Digital communications**
  - **Modbus RTU**
  - **Profibus DP network**
  - **DeviceNet® network**

The 2404/2408 is a versatile, high stability temperature or process controller, with self and adaptive tuning, in 1/4 DIN and 1/8 DIN sizes. It comes with a standard 8 segment setpoint programmer, with options for one, four or twenty programs of 16 segments each.

It has a modular hardware construction which accommodates a wide range of plug-in modules. It will accept up to three I/O modules and two communication modules. Two digital inputs and an optional alarm relay are included as part of the fixed hardware build. The hardware is configurable for heating, cooling, alarms and other functions. A transmitter power supply option is available, as is a 5 or 10V transducer supply option. The 2404/2408 is fully configurable on-site.

The 16 segment programmer can have up to 8 programmable outputs which can be set in each segment to trigger external events. The two digital inputs can be used to run, hold and reset the program. Parallel operation of several programmers can be performed with synchronisation chosen at the end of any desired segments.

### Precise control

An advanced PID control algorithm gives stable 'Straight-line' control of the process. A one-shot tuner is provided to set up the initial PID values and to calculate the overshoot inhibition parameters. In addition an adaptive tuner will handle processes with continually changing characteristics. On electrically heated loads, power feedback is used to stabilise the output power and hence the controlled temperature against supply voltage fluctuations. Dedicated cooling algorithms ensure optimum control of fan, water and oil cooled systems.

### Universal input

A universal input circuit with an advanced analogue to digital convertor samples the input at 9Hz and continuously corrects it for drift. This gives high stability and rapid response to process changes. High noise immunity is achieved by rejection of 50/60Hz pick-up and other sources of noise. Sensor diagnostics are also provided. The input will accept all standard thermocouples, the Pt100 resistance thermometer and linear millivolts, milliamps or DC volts.

## Customisable operation

A custom LED display provides a bright, clear display of the process value and setpoint. Tactile push buttons ensure positive operation. Dedicated buttons provide for auto/manual and program run/hold capabilities. Access to other parameters is simple and easy to understand and can be customised to present only those parameters that need to be viewed or adjusted. All other parameters are locked away under password protection.

## Alarms

Up to four alarms can be combined onto a single output. They can be full scale high or low, deviation from setpoint, rate of change or load failure alarms. Alarm messages are flashed on the main display. Alarms can be configured as latching or non-latching and also as 'blocking' type alarms which means they will become active only after they have first entered a safe state.

## Digital communications

2404/2408 controllers are available with a wide range of communications options. EIA485 2 wire, EIA232, EIA422 4 wire. Profibus DP or Eurotherm® proprietary PDS communications modules are available, offering Modbus RTU, Profibus DP (24xxf), DeviceNet, Eurotherm Bisynch or PDSIO protocols.

## iTools configuration editor

Although 2404/2408 controllers are easily and fully configurable via the front panel, iTools configuration software offers an easy to use PC configuration tool.

iTools has the built-in ability to save or clone instrument configurations ensuring full back up of any engineering effort.



## OPC Scope

OPC Scope is a separate utility that allows trending, data logging and Dynamic Data Exchange (DDE). It is an OPC explorer program that can connect to any OPC server that is in the Windows registry.

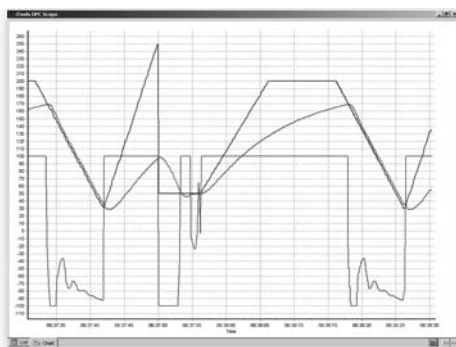

Both data logging and trending are available and the user can trend and view live data, with a scaleable time axis between 1 minute and 1 month. This utility also offers a Historical Review mode and data can be logged onto the PC hard disk, from which it may be retrieved and analysed in an Excel spreadsheet.

## SPECIFICATION

### General

#### Environmental performance

Temperature limits	Operation: 0 to 55°C
	Storage: -10 to 70°C
Humidity limits	Operation: 5 to 90% RH non condensing
	Storage: 5 to 90% RH non condensing

Panel sealing:	IP65
Altitude:	<2000 metres
Atmospheres:	Not suitable for use in explosive or corrosive atmosphere

#### Electromagnetic compatibility (EMC)

Emissions and immunity:	BS EN61326
-------------------------	------------

Suitable for domestic, commercial and light industrial as well as heavy industrial. (Domestic/light (Class B) emissions. Industrial environmental immunity.

Under industrial immunity conditions the instrument will not deviate by more than an additional amount equal to the published tolerance.

#### Electrical safety

BS EN61010	Installation cat. II; Pollution degree 2
------------	--

#### INSTALLATION CATEGORY II

The rated impulse voltage for equipment on nominal 230V mains is 2500V.

#### POLLUTION DEGREE 2

Normally, only non-conductive pollution occurs. Occasionally, however, a temporary conductivity caused by condensation shall be expected

### Physical

Panel mounting	2408: 1/8 DIN
	2404: 1/4 DIN
Weight	2408: 440g max.
	2404: 670g max.
Panel cut-out dims.	2408: 45W x 92Hmm (-0.0 +0.8)
	2404: 92W x 92Hmm (-0.0 +0.8)
Panel depth	Both: 148mm

### Operator interface

Type:	Dual 7 segment LED up to 2 decimal places
Display	2408: Upper 12mm
	Lower 10mm
	2404: Upper 21mm
	Lower 10mm
Status beacons:	OP1, OP2, SP2, REM
Status indicators:	Auto, manual, run, hold
Access levels:	Operator, full access, Edit, config. Password protected

### Power requirements

Supply voltage:	85 to 264Vac,
	48 to 62 Hz,
	2404 16W max.
	2408 13W max.
	24Vac, -15%, +10%
	24Vdc, -15% +20% ±5% ripple voltage

#### Inrush current

High Voltage (VH):	30A duration <100µS
Low Voltage (VL):	15A duration <100µS

### Approvals

CE, cUL listed (file E57766), Gost  
Suitable for use in Nadcap and  
AMS2750D applications under System  
Accuracy Test calibration conditions

### Communications

No of ports:	2 modules can be fitted
Slot allocation:	PDSIO remote setpoint or retransmission J comms port

#### Serial communications option

Protocols:	Modbus RTU Slave Profibus DP (24XXf only) EI-Bisynch (818 style mnemonics)
Isolation:	264Vac, double insulated
Transmission standard:	EIA232, EIA485, CAN (DeviceNet), Profibus (24XXf only)

## Main process variable input

Calibration accuracy:	<±0.2% of reading ±1LSD
Sample rate:	9Hz (110ms)
Isolation:	264Vac double insulation
Input filter:	Off to 999.9. Default 1.6s
Zero offset:	User adjustable over full range
User calibration:	2-point gain & offset
Functions:	Includes process input, remote setpoint, power limit

### Thermocouple

Range:	-100mV to +100mV
Types:	K, J, N, R, S, B, L, T, C, PL2, custom
Resolution (µV):	<3.3µV @ 1.6s filter time
Effective resolution:	15.9 bits
Linearisation accuracy:	<0.2% of reading
Cold junction compensation:	>30:1 rejection of ambient change External reference of 0°C, 45°C and 50°C <±1°C at 25°C ambient

### Cold junction accuracy:

### Resistance thermometer

Range:	0-400Ω (-200°C to +850°C)
Resistance thermometer types:	3-wire Pt100 DIN 43760
Resolution (°C):	<±0.08°C with 1.6sec filter
Effective resolution:	13.7 bits
Linearity error:	<0.033% (best fit straight line)
Calibration error:	<±(0.4°C + 0.15% of reading in °C)
Drift with temperature:	<±(0.015°C + 0.005% of reading in °C) per °C
Common mode rejection:	<0.000085°C/V (maximum of 264Vrms)
Series mode rejection:	<0.240°C/V (maximum of 280mV pk-pk)
Lead resistance:	0Ω to 22Ω, matched lead resistance
Input impedance:	100MΩ
Bulb current:	300µA

### 100mV range

Range:	-100mV to +100mV
Resolution (µV):	<3.3µV with 1.6s filter time
Effective resolution:	15.9 bits
Linearity error:	<0.033% (best fit straight line)
Calibration error:	<±10µV, ± 0.2% of measurement at 25°C
Drift with temperature:	<±0.2µV + 0.004% of reading per °C
Common mode rejection:	>146dB (maximum of 264Vrms)
Series mode rejection:	>90dB (maximum of 280mV pk-pk)
Input impedance:	>100MΩ

### 10 Volts range

Range:	0V to +10.0V
Resolution (µV):	<300µV with 1.6sec filter
Effective resolution:	15.4 bits
Linearity error:	<0.033% (best fit straight line)
Calibration error:	<±(0.4°C + 0.15% of reading in °C)
Drift with temperature:	<± 0.1mV + 0.02% of reading per °C
Common mode rejection:	>145dB (maximum of 264Vrms)
Series mode rejection:	>92dB (maximum of 5V pk-pk)
Input impedance:	>69kΩ

### Notes

- (1) Calibration accuracy quoted over full ambient operating range and for all input linearisation types
- (2) Contact Eurotherm for details of availability of custom downloads for alternative sensors

## Digital input (LA and LB)

Isolation:	Not isolated from each other. 264Vac double insulation from the PSU and communication
------------	---

### Input

Rating	Voltage level: Closed 0 to <11Vdc Open >13 to 24Vdc
	Contact closure: Open >28kΩ Closed <100Ω
Functions:	Includes program control, alarm acknowledge, SP2 select, manual, keylock, RSP select, standby

## AA Relay

Type:	Form C (changeover)
Rating:	Min 1mA @ 1Vdc, Max 2A @ 264Vac resistive 1,000,000 operations with external snubber
Isolation:	264Vac double insulation
Functions:	Alarms, events, status

## DC Input module (Isolated)

Calibration accuracy:	<±0.2% of reading ±1LSD
Sample rate:	9Hz (110ms)
Isolation:	264Vac double insulation
Input filter:	Off to 999.9. Default 1.6s
Zero offset:	User adjustable over full range
User calibration:	2-point gain & offset
Functions:	Includes process input, remote setpoint, power limit

### Thermocouple

Range:	-100mV to +100mV
Types:	K, J, N, R, S, B, L, T, C, PL2, custom
Resolution (µV):	<3.3µV @ 1.6s filter time
Effective resolution:	15.9 bits
Linearisation accuracy:	<0.2% of reading
Cold junction compensation:	>30:1 rejection of ambient change External reference of 0°C, 45°C and 50°C <±1°C at 25°C ambient

### Cold junction accuracy:

### Resistance thermometer

Range:	0-400Ω (-200°C to +850°C)
Resistance thermometer types:	3-wire Pt100 DIN 43760
Resolution (°C):	<±0.08°C with 1.6sec filter
Effective resolution:	13.7 bits
Linearity error:	<0.033% (best fit straight line)
Calibration error:	<±(0.4°C + 0.15% of reading in °C)
Drift with temperature:	<±(0.015°C + 0.005% of reading in °C) per °C
Common mode rejection:	<0.000085°C/V (maximum of 264Vrms)
Series mode rejection:	<0.240°C/V (maximum of 280mV pk-pk)
Lead resistance:	0Ω to 22Ω, matched lead resistance
Input impedance:	100MΩ
Bulb current:	300µA

### 100mV range

Range:	-100mV to +100mV
Resolution (µV):	<3.3µV with 1.6s filter time
Effective resolution:	15.9 bits
Linearity error:	<0.033% (best fit straight line)
Calibration error:	<±10µV, ± 0.2% of measurement at 25°C
Drift with temperature:	<±0.2µV + 0.004% of reading per °C
Common mode rejection:	>146dB (maximum of 264Vrms)
Series mode rejection:	>90dB (maximum of 280mV pk-pk)
Input impedance:	>100MΩ

### 10 Volts range

Range:	-3.0V to +10.0V
Resolution (µV):	<300µV with 1.6sec filter
Effective resolution:	15.4 bits
Linearity error:	<0.033% (best fit straight line)
Calibration error:	<±(0.4°C + 0.15% of reading in °C)
Drift with temperature:	<± 0.1mV + 0.02% of reading per °C
Common mode rejection:	>145dB (maximum of 264Vrms)
Series mode rejection:	>92dB (maximum of 5V pk-pk)
Input impedance:	>69kΩ

## Potentiometer input

Type:	Single channel
Resistance:	100Ω to 15kΩ
Excitation:	0.5Vdc supplied by module
Isolation:	264Vac double insulation
Functions:	Includes valve position and remote setpoint

## Analogue control output

Type:	Single channel
Rating:	0-20mA <600Ω 0-10Vdc >500Ω
Accuracy:	±2.5%
Resolution:	10 bits
Isolation:	264Vac double insulation

## Analogue retransmission output

Type:	Single channel
Rating:	0-20mA <600Ω 0-10Vdc >500Ω
Accuracy:	±0.5%
Resolution:	11 bits
Isolation:	264Vac double insulation

### Logic input modules

Module types: Triple contact closure, triple logic level  
 Isolation: No channel isolation. 264Vac double insulation from other modules and system  
 Rating: Voltage Level: Open -3 to 5Vdc @ <-0.4mA  
 Closed 10.8 to 30Vdc @ 2.5mA  
 Contact closure: Open >28kΩ  
 Closed <100Ω  
 Functions: Includes program control, alarm acknowledge, SP2 select, manual, keylock, RSP select, standby

### Logic output modules

Module types: Single channel, triple channel  
 Isolation: No channel isolation. 264Vac double insulation from other modules and system  
 Rating: Single: 12Vdc @ 24mA, source  
 Triple: 12Vdc @ 9mA, source  
 Functions: Includes control outputs, alarms, events, status

### Relay modules

Module types: Single channel Form A, Single channel Form C, dual channel Form A  
 Isolation: 264Vac double insulation  
 Rating: Min 100mA @ 12Vdc, Max 2A @ 264Vac resistive  
 Min 400,000 (max load) operations with external snubber  
 Functions: Includes control outputs, alarms, events, status

### Triac modules

Module types: Single channel, dual channel  
 Isolation: 264Vac double insulation  
 Rating: <1A @ 30-264Vac resistive  
 Functions: Includes control outputs, alarms, events, status

### Transmitter PSU module

Type: Single channel  
 Isolation: 264Vac double insulation  
 Rating: 24Vdc @ 20mA

### Transducer PSU module

Type: Single channel  
 Isolation: 264Vac double insulation  
 Bridge voltage: Software selectable 5Vdc or 10Vdc  
 Bridge resistance: 300Ω to 15kΩ  
 Internal shunt resistor: 30.1Ω @0.25%, used for calibration of 350Ω bridge at 80%

### Software features

**Control loop**  
 Control types: PID, OnOff, VP, Dual VP  
 Cooling types: Linear, fan, oil, water  
 Modes: Auto, manual, forced manual  
 Overshoot inhibition: High and low cutbacks  
 Number of PID sets: 2, selectable on PV  
 Control options: Supply voltage compensation, feedforward, output tracking, OP power limiting, SBR safe output  
 Setpoint options: Remote SP with trim, SP rate limit, 2nd Setpoint, tracking modes

**Setpoint programmer**  
 Program function: Standard 1, 8 segment  
 Optional 1, 4 or 20, 16 segment  
 8 with 16 segment programmer  
 Ramp rate, Ramp time, dwell, call, step  
 Run, Hold, Reset, RunHold, RunReset, ResetRun, Adv Seg, Skip Seg  
 Process value, setpoint  
 Power failure modes: Continue, ramp, reset  
 Other functions: Holdback, inputs

**Process alarms**  
 Number: 4  
 Type: High, low, devhi, devlo, devband  
 Latching: None, auto, manual, event  
 Other features: Blocking

## Isolation diagram

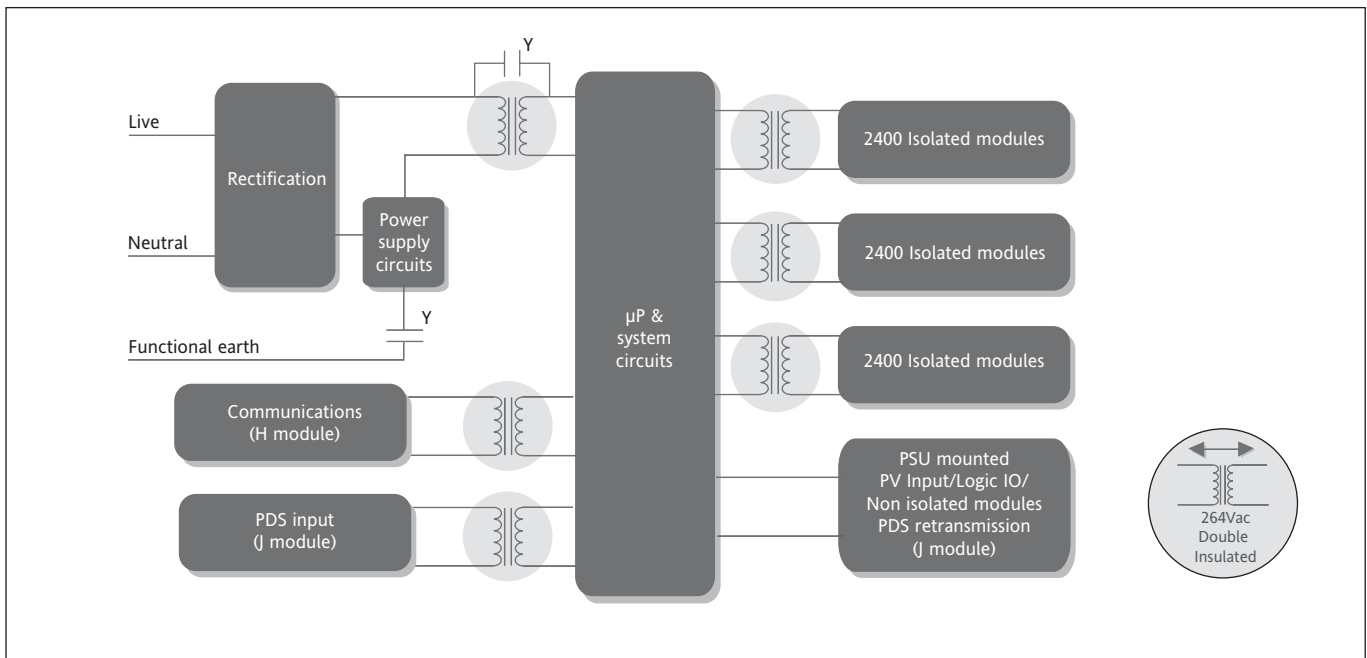

## PDSIO load diagnostics

PDSIO (Pulse Density Signalling I/O) is a major innovation in the 2404/2408. When used in combination with a Eurotherm TE10 solid state relay (SSR), it allows the logic output of a 2404/2408 to transmit the power demand signal and simultaneously read back load fault alarms. These alarms will be flashed as messages on the controller front panel.

Two alarm conditions will be detected, either SSR failure indicating an open or short circuit condition in the SSR and heater circuit failure indicating either fuse failure, heater open circuit or line supply absent.

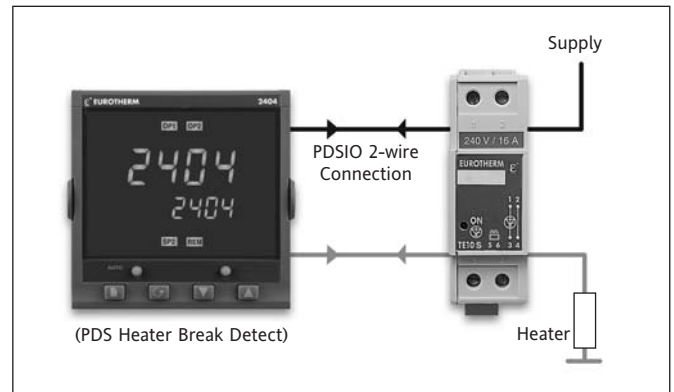

## PDSIO master setpoint transmission

PDSIO can be used to digitally transmit the setpoint profile to a number of slave Series 2000 controllers.

If any slave zone departs from the required setpoint by more than a pre-settable amount, a signal from any slave can be transmitted back to the master causing the program to freeze until the error is corrected. Digital accuracy is preserved using PDSIO.

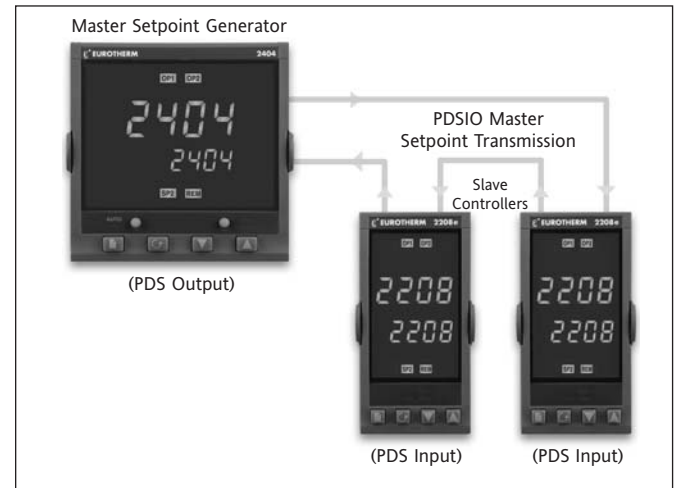

## Rear terminal connections

2408

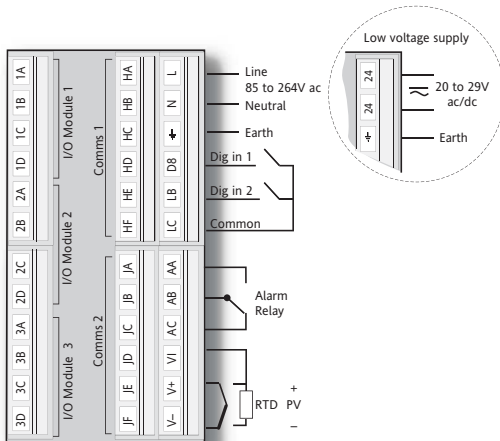

2404

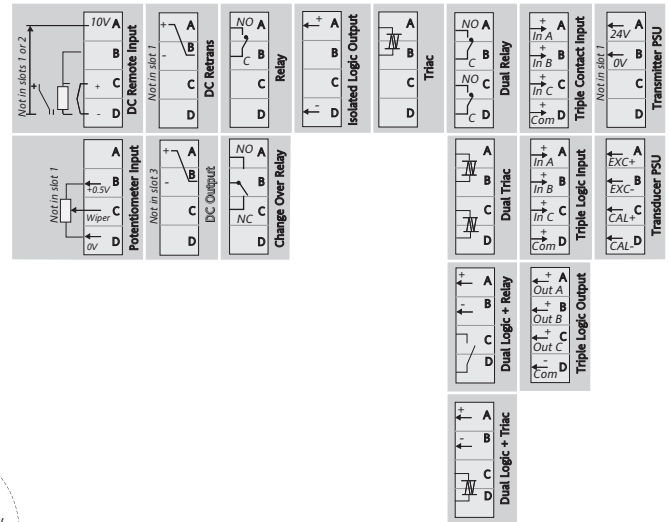
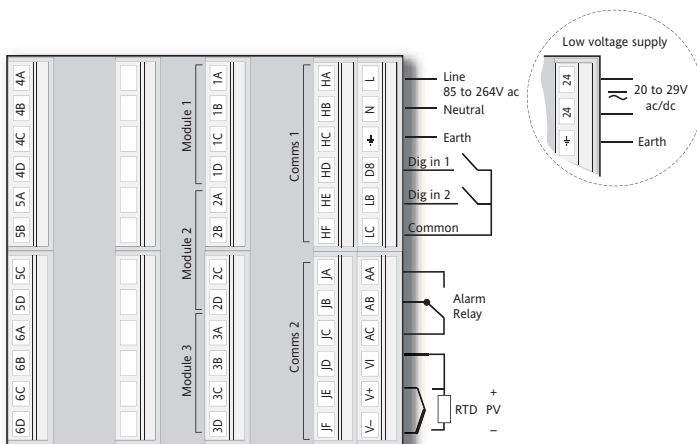

# Hardware coding

Model Number	Function	Supply Voltage	Module 1	Module 2	Module 3	Alarm Relay	10amp Output	Comms 1	Comms 2	Manual
							Omit for 2408			

2408

2404

Model Number	
2408	48x96mm
2404	96x96mm
<b>Profibus units</b>	
2408f	48x96mm
2404f	96x96mm

Function (2408)	
<b>PID control</b>	
CC	Controller only
CG	1x 8 seg Prog
CP	1x16 seg Prog
P4	4x16 seg Prog
CM	20x16 seg Prog (note 1)
<b>On/Off Control</b>	
NF	Controller only
NG	1x8 seg Prog
NP	1x16 seg Prog
N4	4x16 seg Prog
NM	20x16 seg Prog (note 1)
<b>Motorised valve control</b>	
VC	Valve positioner
VG	1x8 seg Prog
VP	1x16 seg Prog
V4	4x16 seg Prog
VM	20x16 seg Prog (note 1)

Function (2404)	
<b>PID control</b>	
CC	Controller only
CG	1x 8 seg Prog
CP	1x16 seg Prog
P4	4x16 seg Prog
CM	20x16 seg Prog (note 1)
<b>On/Off Control</b>	
NF	Controller only
NG	1x8 seg Prog
NP	1x16 seg Prog
N4	4x16 seg Prog
NM	20x16 seg Prog (note 1)
<b>Motorised valve control</b>	
VC	Valve positioner
VG	1x 8 seg Prog
VP	1x16 seg Prog
V4	4x16 seg Prog
VM	20x16 seg Prog (note 1)

Supply Voltage	
VH	85-264Vac
VL	20-29Vac/dc

Module 1	
XX	Not fitted
<b>Relay: 2-pin</b>	
R2	Fitted unconfigured
RH	Heating output
RU	Valve raise output
<b>Relay: change over</b>	
R4	Fitted unconfigured
YH	Heating output
RP	Valve raise (note 6)
<i>Or alarm 1 from table A</i>	
<b>Logic: (Non-isolated)</b>	
L2	Fitted unconfigured
LH	Heating output
M1	PDS Heater break detect (note 2)
M2	PDS Current monitoring (note 3)
<b>Logic: (Isolated)</b>	
LO	Single logic OP
<b>Triac</b>	
T2	Fitted unconfigured
TH	Heating output
TU	Valve raise output
<b>DC control (Isolated)</b>	
D4	Fitted unconfigured
H6	0-20mA heating
H7	4-20mA heating
H8	0-5V heating
H9	1-5V heating
HZ	0-10V heating
<b>Digital I/O (unconfig'd)</b>	
TK	Triple contact input
TL	Triple logic input
TP	Triple logic output
<b>Dual relay</b>	
RR	Fitted unconfigured
RD	Heat + cool
RM	VP raise & lower OPs
<b>Dual triac</b>	
TT	Fitted unconfigured
TD	Heat + cool
TM	VP raise & lower OPs
<b>Logic+relay</b>	
LR	Fitted unconfigured
LD	Heat + cool
QC	Mode 2 + cool
<b>Logic+triac</b>	
LT	Fitted unconfigured
GD	Heat + cool
QD	Mode 2 + cool
<b>Transducer PS</b>	
G3	5Vdc transducer PSU
G5	10Vdc transducer PSU
<b>Table A: alarm codes</b>	
FH	High alarm
FL	Low alarm
DB	Dev. band alarm
DL	Dev. low alarm
DH	Dev. high alarm

Module 2	
XX	Not fitted
<b>Relay: 2-pin</b>	
R2	Fitted unconfigured
RC	Cooling output
RW	Valve lower output
<b>Relay: change over</b>	
R4	Fitted unconfigured
YC	Cooling output
RL	Valve lower (note 6)
PO	Program event 1 (note 7)
PE	Program END output
<i>Or alarm 2 from table A</i>	
<b>Dual relay</b>	
RR	Fitted unconfigured
PP	Program events 1 & 2 (note 7)
<b>Logic: (Non-isolated)</b>	
L2	Fitted unconfigured
LC	Cooling output
<b>Logic: (Isolated)</b>	
LO	Single logic OP
<b>Triac</b>	
T2	Fitted unconfigured
TC	Cooling output
TW	Valve lower output
<b>DC control (Isolated)</b>	
D4	Fitted unconfigured
C6	0-20mA cooling
C7	4-20mA cooling
C8	0-5V cooling
C9	1-5V cooling
CZ	0-10V cooling
<b>Digital I/O (unconfig'd)</b>	
TK	Triple contact input
TL	Triple logic input
TP	Triple logic output
<b>Power supply</b>	
MS	24Vdc transmitter
<b>DC retrans. (Isolated)</b>	
<i>Select from Table B</i>	
<b>Potentiometer input</b>	
VU	Fitted unconfigured
VS	Valve position feedback
VR	Setpoint input
<b>Transducer PS</b>	
G3	5Vdc transducer PSU
G5	10Vdc transducer PSU
<b>Table B: DC retransmission</b>	
D6 Fitted unconfigured	
First character	
V-	PV retrans
S-	Setpoint retrans
O-	Output retrans
Z-	Error retrans
Second character	
-1	0-20mA
-2	4-20mA
-3	0-5V
-4	1-5V
-5	0-10V

Module 3	
XX	Not fitted
<b>Relay: 2-pin</b>	
R2	Fitted unconfigured
<b>Relay: change over</b>	
R4	Fitted unconfigured
PO	Program event 4 (note 7)
PE	Program END output
<i>Or alarm 3 from table A</i>	
<b>Logic: (Non-isolated)</b>	
L2	Fitted unconfigured
<b>Logic: (Isolated)</b>	
LO	Single logic OP
<b>Triac</b>	
T2	Fitted unconfigured
<b>Dual relay</b>	
RR	Fitted unconfigured
PP	Program event 4 & 5 (note 7)
<b>Digital I/O (unconfig'd)</b>	
TK	Triple contact input
TL	Triple logic input
TP	Triple logic output
<b>Power supply</b>	
MS	24Vdc transmitter
<b>DC remote input</b>	
D5	Fitted unconfigured
W2	4-20mA setpoint
W5	0-10V setpoint
WP	Second PV input
<b>DC retrans. (Isolated)</b>	
<i>Select from Table B</i>	
<b>Potentiometer input</b>	
VU	Fitted unconfigured
VS	Valve position feedback
VR	Setpoint input

Alarm relay	
XX	Not fitted
<b>Alarm 4 relay</b>	
RF	Fitted unconfigured
<i>Table A alarm options plus:</i>	
RA	Rate of change alarm
<i>PDS Alarms</i>	
LF	Heater break detect
HF	Current monitoring heater break
SF	Current monitoring SSR failure
PO	Program event 7 (note 7)
PE	Program END output

10amp Output	
XX	Not fitted

Comms 1	
XX	Not fitted
<b>2 wire, EIA485</b>	
Y2	Fitted unconfigured
YM	Modbus protocol
YE	El-Bisynch protocol (note 1)
<b>EIA232</b>	
A2	Fitted unconfigured
AM	Modbus protocol
AE	El-Bisynch protocol (note 1)
<b>4 wire EIA422</b>	
F2	Fitted unconfigured
FM	Modbus protocol
FE	El-Bisynch protocol (note 1)
<b>PDS Output</b>	
M7	Fitted unconfigured
PT	PV retrans
TS	Setpoint retrans
OT	Output retrans
<b>Profibus Module</b>	
PB	Profibus (note 6)
<b>DeviceNet</b>	
DN	DeviceNet

Comms 2	
XX	Not fitted
<b>PDS Input</b>	
M6	Fitted unconfigured
RS	Setpoint input
<b>PDS Output</b>	
M7	Fitted unconfigured
PT	PV retrans
TS	Setpoint retrans
OT	Output retrans

Manual	
XXX	No manual
ENG	English
FRA	French
GER	German
NED	Dutch
SPA	Spanish
SWE	Swedish
ITA	Italian

## 2404/2408 Accessories

Handbook	HA025132
Communications handbook	HA026230
Profibus DP handbook	HA026290
2.49Ω precision resistor	SUB24/2R49.1

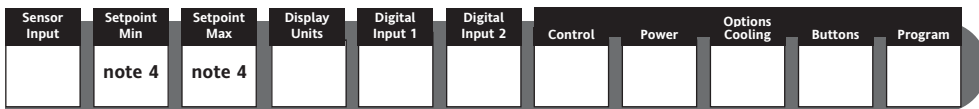

Sensor Input		Setpoint Min	Setpoint Max
<b>Standard Sensor Inputs</b>			
J	J Thermocouple	-210	1200
K	K Thermocouple	-200	1372
T	T Thermocouple	-200	400
L	L Thermocouple	-200	900
N	N Thermocouple-Nicrosil/Nisil	-250	1300
R	R Thermocouple-Pt/Pt13%Rh	-50	1700
S	S Thermocouple-Pt/Pt10%Rh	-50	1768
B	B Thermocouple-Pt/Pt30%Rh -6%Rh	0	1820
P	Platinel II Thermocouple	0	1369
Z	RTD/PT100 DIN 43760	-200	850
<b>Factory Downloaded Input</b>			
C	C Thermocouple - W5%Re/W26%Re (Hoskins)	0	2319
D	D Thermocouple - W3%Re/W25%Re	0	2399
E	E Thermocouple	-250	1000
1	Ni/Ni18%Mo Thermocouple	0	1399
2	Pt20%Rh/Pt40%Rh Thermocouple	0	1870
3	W/W26%Re (Engelhard) Thermocouple	0	2000
4	W/W26%Re (Hoskins) Thermocouple	0	2010
5	W5%Re/W26%Re (Engelhard) Thermocouple	10	2300
6	W5%Re/W26%Re (Bucose) Thermocouple	0	2000
7	Pt10%Rh/Pt40%Rh Thermocouple	200	1800
8	Exergen K80 I.R. pyrometer	-45	650
<b>Process Inputs (Scaled to setpoint min and max)</b>			
F	-100 to +100mV linear	-1999	9999
Y	0 to 20mA linear (note 4)	-1999	9999
A	4 to 20mA linear (note 4)	-1999	9999
W	0 to 5Vdc linear	-1999	9999
G	1 to 5Vdc linear	-1999	9999
V	0 to 10Vdc linear	-1999	9999

Display Units	
C	Celsius
F	Fahrenheit
K	Kelvin
X	Linear input

Digital Input 1 & 2	
XX	Disabled
AM	Manual select
SR	Remote SP select
S2	Second setpoint
EH	Integral hold
AC	Alarm acknowledge
RP	SP rate limit enabled
RN	Run program
HO	Hold program
RE	Reset program
RH	Run/hold prog
KL	Keylock
NT	Run/Reset
TN	Reset/Run
HB	Program holdback
P2	Second PID
ST	One shot tune enable
AT	Adaptive tune enable
FA	Select full access level
RB	Simulates UP button
LB	Simulates DOWN button
SB	Simulates SCROLL button
PB	Simulates PAGE button
B1	Least sig. BCD digit
B2	2nd BCD digit
B3	3rd BCD digit
B4	4th BCD digit
B5	5th BCD digit
B6	Most significant digit
SY	Standby-all O/Ps OFF
SC	Prog synchronisation
SG	Skip segment (without changing SP)
PV	Select PV2
AG	Advance to end of segment(& step to target SP)
M5	CTX (mode 5) Input 2 only

Options	
<b>Control action</b>	
XX	Reverse acting (standard)
DP	Direct acting
<b>Power feedback</b>	
XX	Enabled on logic, relay & triac heating
PD	Feedback disabled
<b>Cooling options</b>	
XX	Linear cooling
CF	Fan cooling
CW	Water cooling
CL	Oil cooling
NT	On/Off cooling
<b>Front panel buttons</b>	
XX	Enabled
MD	Auto/manual disabled
MR	Auto/man & run/hold disabled
RD	Run/hold disabled
<b>Programmer time units</b>	
XX	Dwell & ramp in mins
HD	Dwell time in hours
HR	Ramp rate in units/hrs
HT	Ramp/dwell hours

Note 1.  
Not available with profibus controllers

Note 2.  
PDS heater break detect will transmit the power demand to a TE10S Solid State Relay and read back a heater break alarm.

Note 3.  
PDS current monitoring will transmit the power demand signal to a TE10S Solid State Relay and read back load current and open and short circuit alarms.

Note 4.  
Setpoint limits: Include the decimal position required in the displayed value. Up to one for temperature inputs, up to two for process inputs.

Note 5.  
An external 1% current sense resistor is supplied as standard. If greater accuracy is required, a 0.1% 2.49Ω can be ordered as part no. SUB2K/249R.1.

Note 6.  
Only available with Profibus controller.

Note 7.  
Not available with 8 segment programmer

### Example ordering code

2408 - CC - VH - LH - RC - FL - FH - YM - TS - K - 0 - 1000 - C - AM - S2 - XX - XX - XX - MD - XX

2408, PID Controller, 85 to 264Vac, Logic heating, Relay cooling, Low alarm relay, High alarm relay, RS485, Modbus comms, PDSIO setpoint retrans, Type K thermocouple, 0 to 1000°C, Auto/manual select, 2nd setpoint select, Manual button disabled.

## Dimensional details

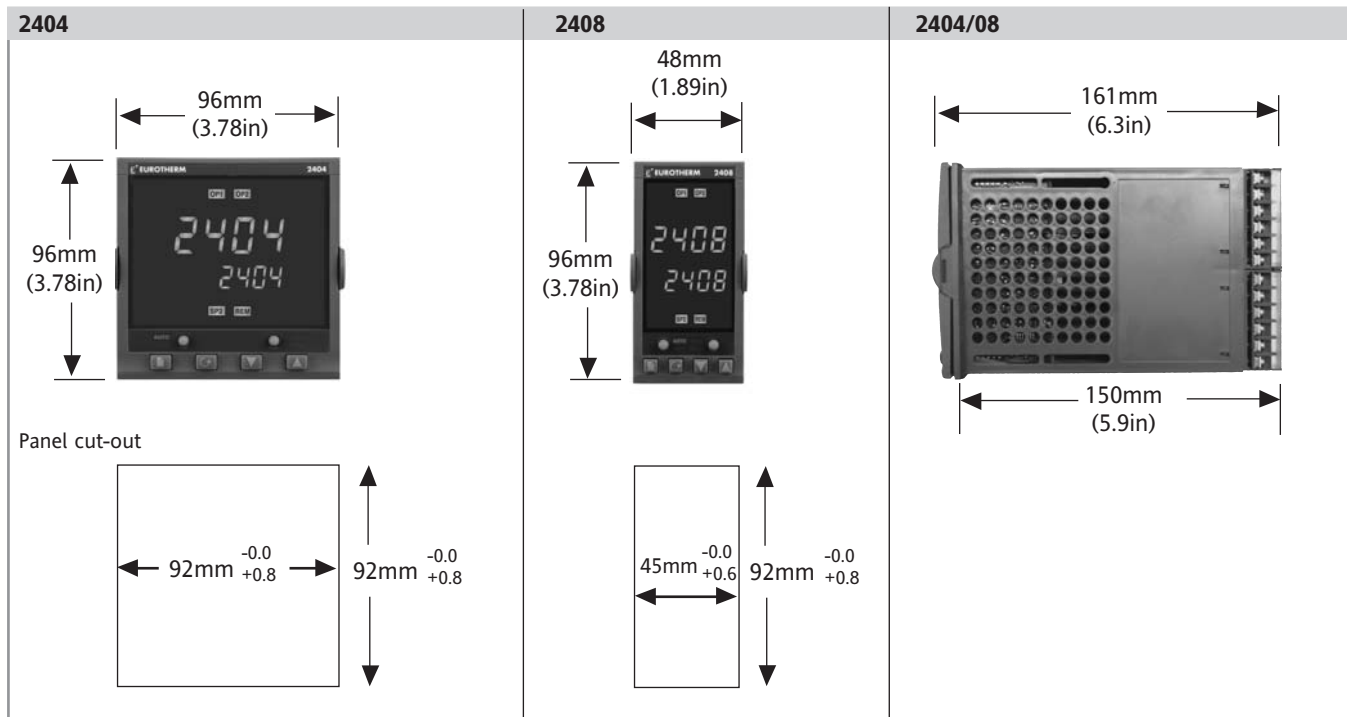

## Eurotherm: International sales and service

Understanding and providing local support is a key part of Eurotherm's business. Complementing worldwide Eurotherm offices are a whole range of partners and a comprehensive technical support team... to ensure you get a service you will want to go back to.

**AUSTRALIA** Sydney  
Eurotherm Pty. Ltd.  
T (+61 2) 9838 0099  
F (+61 2) 9838 9288  
E [info.au@eurotherm.com](mailto:info.au@eurotherm.com)

**AUSTRIA** Vienna  
Eurotherm GmbH  
T (+43 1) 7987601  
F (+43 1) 7987605  
E [info.at@eurotherm.com](mailto:info.at@eurotherm.com)

**BELGIUM & LUXEMBOURG** Moha  
Eurotherm S.A/N.V.  
T (+32) 85 274080  
F (+32) 85 274081  
E [info.be@eurotherm.com](mailto:info.be@eurotherm.com)

**BRAZIL** Campinas-SP  
Eurotherm Ltda.  
T (+5519) 3707 5333  
F (+5519) 3707 5345  
E [info.br@eurotherm.com](mailto:info.br@eurotherm.com)

**DENMARK** Copenhagen  
Eurotherm Danmark AS  
T (+45 70) 234670  
F (+45 70) 234660  
E [info.dk@eurotherm.com](mailto:info.dk@eurotherm.com)

**FINLAND** Abo  
Eurotherm Finland  
T (+358) 22506030  
F (+358) 22503201  
E [info.fi@eurotherm.com](mailto:info.fi@eurotherm.com)

**FRANCE** Lyon  
Eurotherm Automation SA  
T (+33 478) 664500  
F (+33 478) 352490  
E [info.fr@eurotherm.com](mailto:info.fr@eurotherm.com)

**GERMANY** Limburg  
Eurotherm Deutschland GmbH  
T (+49 6431) 2980  
F (+49 6431) 298119  
E [info.de@eurotherm.com](mailto:info.de@eurotherm.com)

**HONG KONG & CHINA**  
Eurotherm Limited North Point  
T (+85 2) 28733826  
F (+85 2) 28700148  
E [info.hk@eurotherm.com](mailto:info.hk@eurotherm.com)

Guangzhou Office  
T (+86 20) 8755 5099  
F (+86 20) 8755 5831  
E [info.cn@eurotherm.com](mailto:info.cn@eurotherm.com)

Beijing Office  
T (+86 10) 6567 8506  
F (+86 10) 6567 8509  
E [info.cn@eurotherm.com](mailto:info.cn@eurotherm.com)

Shanghai Office  
T (+86 21) 6145 1188  
F (+86 21) 6145 1187  
E [info.cn@eurotherm.com](mailto:info.cn@eurotherm.com)

**INDIA** Chennai  
Eurotherm India Limited  
T (+91 44) 24961129  
F (+91 44) 24961831  
E [info.in@eurotherm.com](mailto:info.in@eurotherm.com)

**IRELAND** Dublin  
Eurotherm Ireland Limited  
T (+353 1) 4691800  
F (+353 1) 4691300  
E [info.ie@eurotherm.com](mailto:info.ie@eurotherm.com)

**ITALY** Como  
Eurotherm S.r.l.  
T (+39 31) 975111  
F (+39 31) 977512  
E [info.it@eurotherm.com](mailto:info.it@eurotherm.com)

**KOREA** Seoul  
Eurotherm Korea Limited  
T (+82 31) 2738507  
F (+82 31) 2738508  
E [info.kr@eurotherm.com](mailto:info.kr@eurotherm.com)

**NETHERLANDS** Alphen a/d Rijn  
Eurotherm B.V.  
T (+31 172) 411752  
F (+31 172) 417260  
E [info.nl@eurotherm.com](mailto:info.nl@eurotherm.com)

**NORWAY** Oslo  
Eurotherm A/S  
T (+47 67) 592170  
F (+47 67) 118301  
E [info.no@eurotherm.com](mailto:info.no@eurotherm.com)

**POLAND** Katowice  
Invensys Eurotherm Sp z o.o.  
T (+48 32) 2185100  
F (+48 32) 2177171  
E [info.pl@eurotherm.com](mailto:info.pl@eurotherm.com)

**SPAIN** Madrid  
Eurotherm España SA  
T (+34 91) 6616001  
F (+34 91) 6619093  
E [info.es@eurotherm.com](mailto:info.es@eurotherm.com)

**SWEDEN** Malmo  
Eurotherm AB  
T (+46 40) 384500  
F (+46 40) 384545  
E [info.se@eurotherm.com](mailto:info.se@eurotherm.com)

**SWITZERLAND** Wollerau  
Eurotherm Produkte (Schweiz) AG  
T (+41 44) 7871040  
F (+41 44) 7871044  
E [info.ch@eurotherm.com](mailto:info.ch@eurotherm.com)

**UNITED KINGDOM** Worthing  
Eurotherm Limited  
T (+44 1903) 268500  
F (+44 1903) 265982  
E [info.uk@eurotherm.com](mailto:info.uk@eurotherm.com)  
[www.eurotherm.co.uk](http://www.eurotherm.co.uk)

**U.S.A.** Leesburg VA  
Eurotherm Inc.  
T (+1 703) 443 0000  
F (+1 703) 669 1300  
E [info.us@eurotherm.com](mailto:info.us@eurotherm.com)  
[www.eurotherm.com](http://www.eurotherm.com)

ED53

© Copyright Eurotherm Limited 2007

Invensys, Eurotherm, the Eurotherm logo, Chessell, EurothermSuite, Mini8, Eycou, Eyriss and Wonderware are trademarks of Invensys plc, its subsidiaries and affiliates. All other brands may be trademarks of their respective owners.

All rights are strictly reserved. No part of this document may be reproduced, modified, or transmitted in any form by any means, nor may it be stored in a retrieval system other than for the purpose to act as an aid in operating the equipment to which the document relates, without the prior written permission of Eurotherm limited.

Eurotherm Limited pursues a policy of continuous development and product improvement. The specifications in this document may therefore be changed without notice. The information in this document is given in good faith, but is intended for guidance only.

Eurotherm Limited will accept no responsibility for any losses arising from errors in this document.

